



Polycrystalline Solar PV Modules

IEC61215/61730 Quality/ ISO Certified Company

Model No. FDS050-12P



50W

Temperature Coefficients

Nominal Operating Cell Temperature	NOCT	°C	45 +/-2
Voltage Temperature Coefficient (Voc)	α	%/°C	-0.32
Current Temperature Coefficient (Isc)	β	%/°C	0.055
Power Temperature Coefficient (Pmpp)	γ	%/°C	-0.39

Mechanical Data

Solar Cell	Poly-crystalline, 156.75*52.25mm		
Arrangement	36Cells (4*9)		
Front Glass	3.2mm Tempered		
Frame	Anodized Aluminium		
Max. Static Snow Load, Front	5400Pa		
Max. Static Wind Load, Back	2400Pa		
Junction Box	IP67		
Cables & Connectors	As Per Requirement		

Electrical Data

STC: Irradiance 1000 W/m²(module temperature 25°C AM1.5)

Module Type	FDS050-12P		
Nominal Peak Power	Pmax	Wp	50
Minimum Power Tolerance	ΔP_{max}	%	-/+3
Max. Power Voltage	Vmp	V	18.2
Max. Power Current	Imp	A	2.75
Open-circuit Voltage	Voc	V	22.4
Short-circuit Current	Isc	A	2.95
Module Efficiency	η_m	%	14.8
Operating Temperature		°C	-40 to +85
Max Series Fuse Rating		A	10
Max. System voltage	DC	V	1,000
Weight		KGS	3.6
Dimension		MM	535*670*25

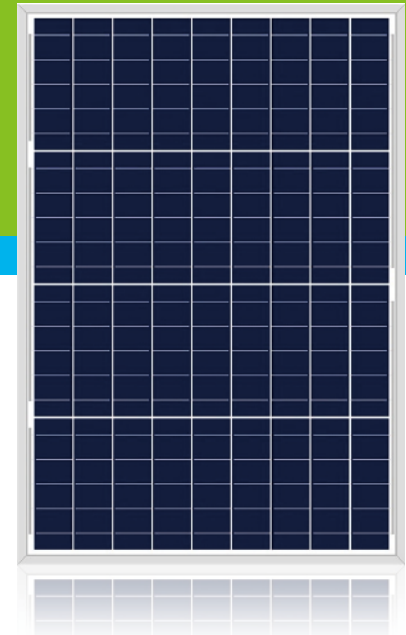

Dimensions unit : mm

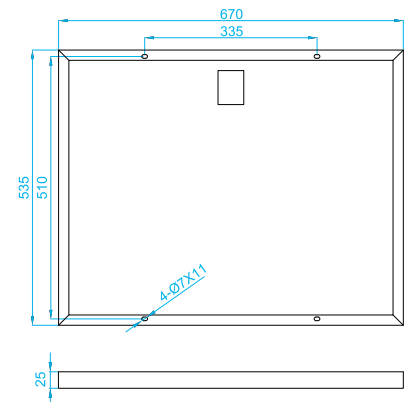

Materials & Workmanship Warranty



90% Power Output Warranty



80% Power Output Warranty

Warranty : Solar Modules with 25 years warranty

#2, North Second Ring Road, Zhangjiagang City, China, 215600

Tel: 0086-512-58542102

Email: sales@fortunes-solar.com.cn

Website: www.fortunes-solar.com.cn

