



Monocrystalline Solar PV Modules

IEC61215/61730 Quality/ ISO Certified Company

Model No. FDS050-12M10

50W

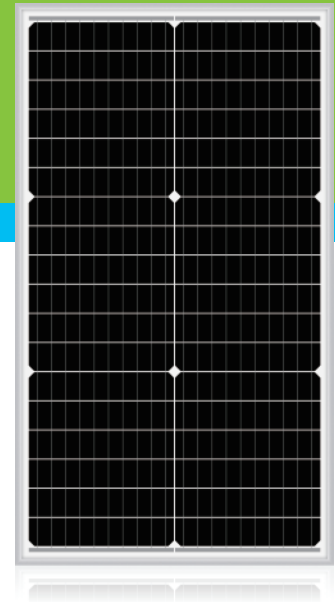

Temperature Coefficients

Nominal Operating Cell Temperature	NOCT	°C	45 +/-2
Voltage Temperature Coefficient (Voc)	α	%/°C	-0.32
Current Temperature Coefficient (Isc)	β	%/°C	0.055
Power Temperature Coefficient (Pmp)	γ	%/°C	-0.39

Mechanical Data

Solar Cell	Monocrystalline, 182*35mm
Arrangement	36Cells (2*18)
Front Glass	3.2mm Tempered
Frame	Anodized Aluminium
Max. Static Snow Load, Front	5400Pa
Max. Static Wind Load, Back	2400Pa
Junction Box	IP65
Cables & Connectors	As Per Requirement

Electrical Data

STC: Irradiance 1000 W/m²(module temperature 25°C AM1.5)

Module Type	FDS050-12M10		
Nominal Peak Power	P _{max}	Wp	50
Minimum Power Tolerance	ΔP_{max}	%	-/+3
Max. Power Voltage	V _{mp}	V	20.2
Max. Power Current	I _{mp}	A	2.48
Open-circuit Voltage	V _{oc}	V	24.0
Short-circuit Current	I _{sc}	A	2.68
Module Efficiency	η_m	%	17.7
Operating Temperature		°C	-40 to +85
Max Series Fuse Rating		A	3
Max. System voltage	DC	V	1,000
Weight		KGS	3.0
Dimension		MM	705*400*25

Dimensions unit : mm

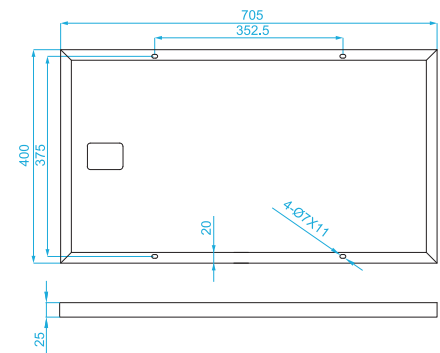

Materials & Workmanship Warranty



90% Power Output Warranty



80% Power Output Warranty

Warranty : Solar Modules with 25 years warranty

#348, North Second Ring Road, Zhangjiagang City, China, 215600

Tel : 0086-512-58542102 Fax : 0086-512-58542707

Email : sales@fortunes-solar.com.cn

Website : www.fortunes-solar.com

