



# Monocrystalline Solar PV Modules

IEC61215/61730 Quality/ ISO Certified Company

Model No. **FDS120-12M10**

**120W**

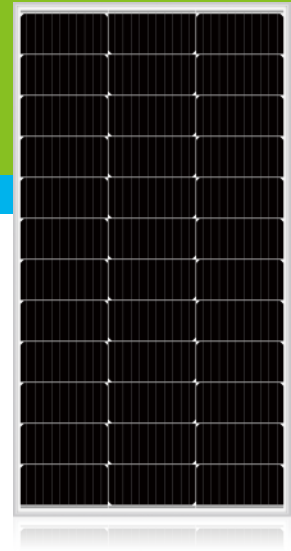

## Temperature Coefficients

Nominal Operating Cell Temperature	NOCT	°C	45 +/-2
Voltage Temperature Coefficient (Voc)	$\alpha$	%/°C	-0.32
Current Temperature Coefficient (Isc)	$\beta$	%/°C	0.055
Power Temperature Coefficient (Pmpp)	$\gamma$	%/°C	-0.39

## Mechanical Data

Solar Cell	Monocrystalline, 182*84mm
Arrangement	36Cells (3*12)
Front Glass	3.2mm Tempered
Frame	Anodized Aluminium
Max. Static Snow Load, Front	5400Pa
Max. Static Wind Load, Back	2400Pa
Junction Box	IP65
Cables & Connectors	As Per Requirement

## Electrical Data

STC: Irradiance 1000 W/m<sup>2</sup>(module temperature 25°C AM1.5)

Module Type	FDS120-12M10		
Nominal Peak Power	Pmax	Wp	120
Minimum Power Tolerance	$\Delta P_{max}$	%	-/+3
Max. Power Voltage	Vmp	V	20.2
Max. Power Current	Imp	A	5.94
Open-circuit Voltage	Voc	V	24.0
Short-circuit Current	Isc	A	6.46
Module Efficiency	$\eta_m$	%	19.2
Operating Temperature		°C	-40 to +85
Max Series Fuse Rating		A	8
Max. System voltage	DC	V	1,000
Weight		KGS	6.6
Dimension		MM	1075*580*30

Dimensions unit : mm

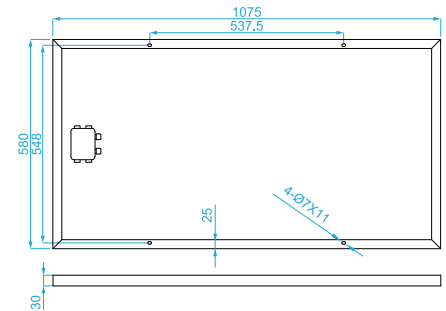

Materials & Workmanship Warranty



90% Power Output Warranty



80% Power Output Warranty

Warranty : Solar Modules with 25 years warranty

#348, North Second Ring Road, Zhangjiagang City, China, 215600

Tel : 0086-512-58542102 Fax : 0086-512-58542707

Email : sales@fortunes-solar.com.cn

Website : www.fortunes-solar.com

