



Monocrystalline Solar PV Modules

IEC61215/61730 Quality/ ISO Certified Company

Model No. FDS350-24M10

350W

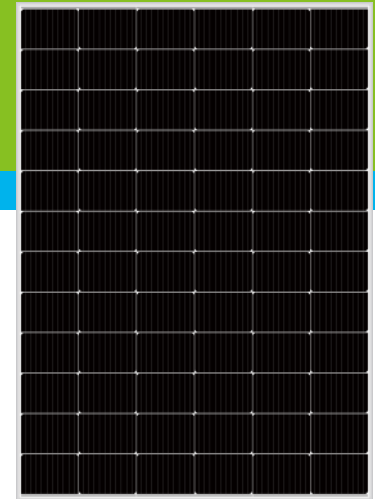

Temperature Coefficients

Nominal Operating Cell Temperature	NOCT	°C	45 +/-2
Voltage Temperature Coefficient (Voc)	α	%/°C	-0.32
Current Temperature Coefficient (Isc)	β	%/°C	0.055
Power Temperature Coefficient (Pmpp)	γ	%/°C	-0.39

Mechanical Data

Solar Cell	Monocrystalline, 182*126mm		
Arrangement	72Cells (6*12)		
Front Glass	3.2mm Tempered		
Frame	Anodized Aluminium		
Max. Static Snow Load, Front	5400Pa		
Max. Static Wind Load, Back	2400Pa		
Junction Box	IP67		
Cables & Connectors	As Per Requirement		

Electrical Data

STC: Irradiance 1000 W/m²(module temperature 25°C AM1.5)

Module Type	FDS350-24M10		
Nominal Peak Power	Pmax	Wp	350
Minimum Power Tolerance	ΔP_{max}	%	-/+3
Max. Power Voltage	Vmp	V	39.4
Max. Power Current	Imp	A	8.88
Open-circuit Voltage	Voc	V	47.1
Short-circuit Current	Isc	A	9.66
Module Efficiency	η_m	%	19.5
Operating Temperature		°C	-40 to +85
Max Series Fuse Rating		A	15
Max. System voltage	DC	V	1,500
Weight		KGS	18.7
Dimension		MM	1585*1132*30

Dimensions unit : mm

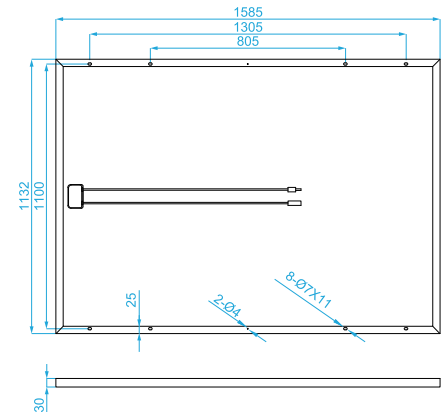

Materials & Workmanship Warranty



90% Power Output Warranty



80% Power Output Warranty

Warranty : Solar Modules with 25 years warranty

#348, North Second Ring Road, Zhangjiagang City, China, 215600

Tel : 0086-512-58542102 Fax : 0086-512-58542707

Email : sales@fortunes-solar.com.cn

Website : www.fortunes-solar.com

