



Monocrystalline Solar PV Modules

IEC61215/61730 Quality/ ISO Certified Company

Model No. FDS370-24M10

370W

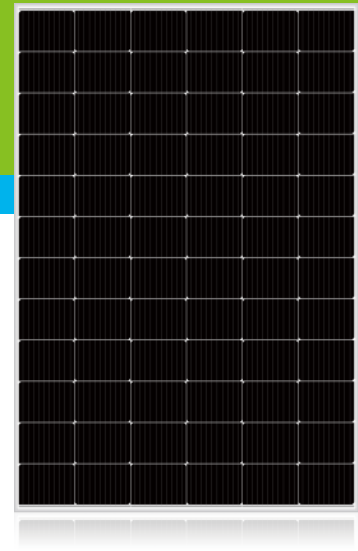

Temperature Coefficients

Nominal Operating Cell Temperature	NOCT	°C	45 +/-2
Voltage Temperature Coefficient (Voc)	α	%/°C	-0.32
Current Temperature Coefficient (Isc)	β	%/°C	0.055
Power Temperature Coefficient (Pmp)	γ	%/°C	-0.39

Mechanical Data

Solar Cell	Monocrystalline, 182*133mm
Arrangement	72Cells (6*12)
Front Glass	3.2mm Tempered
Frame	Anodized Aluminium
Max. Static Snow Load, Front	5400Pa
Max. Static Wind Load, Back	2400Pa
Junction Box	IP67
Cables & Connectors	As Per Requirement

Electrical Data

STC: Irradiance 1000 W/m²(module temperature 25°C AM1.5)

Module Type	FDS370-24M10		
Nominal Peak Power	P _{max}	Wp	370
Minimum Power Tolerance	ΔP_{max}	%	-/+3
Max. Power Voltage	V _{mp}	V	39.4
Max. Power Current	I _{mp}	A	9.39
Open-circuit Voltage	V _{oc}	V	47.1
Short-circuit Current	I _{sc}	A	10.21
Module Efficiency	η_m	%	19.6
Operating Temperature		°C	-40 to +85
Max Series Fuse Rating		A	15
Max. System voltage	DC	V	1,500
Weight		KGS	19.7
Dimension		MM	1670*1132*30

Dimensions unit : mm

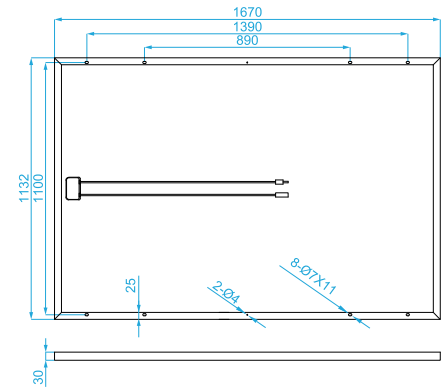

Materials & Workmanship Warranty



90% Power Output Warranty



80% Power Output Warranty

Warranty : Solar Modules with 25 years warranty

#348, North Second Ring Road, Zhangjiagang City, China, 215600

Tel : 0086-512-58542102 Fax : 0086-512-58542707

Email : sales@fortunes-solar.com.cn

Website : www.fortunes-solar.com

